



Made in Denmark



Danish Design · Danish Quality · Danish Production

Key to symbols



Thanks to first-class manufacturing, robust construction and high-quality materials – including cast-iron doors. Heta A/S stoves are ideal for constant use with approved smokeless fuels.*



The patented 8-litre Heta ash pan is an outstanding and practical detail. The ash pan makes ash removal easy and is highly functional, avoiding a mess in the living room. The ash pan fits neatly into the combustion chamber from below and ensures that combustion is clean and efficient.



The patented 3-litre Heta ash pan is an outstanding and practical detail. The ash pan makes ash removal easy and is highly functional, avoiding a mess in the living room. The ash pan fits neatly into the combustion chamber from below and ensures that combustion is clean and efficient.



As an option, Heta stoves can be fitted with a swivel plinth and flexible flue. When fitted with these accessories, almost all Heta A/S' stoves can be made to rotate. The rotation arc is 120°- 180°. Stoves with a swivel function will typically have a top flue outlet.



The stove is supplied as standard with a swivel function. The rotation arc is 90°- 180°. The stove can be locked in the desired position. Stoves with a swivel function will need to use the top flue outlet.



The convection air STOP function allows the user to shut off convection air flow after the heating phase in order to direct the flow of heat energy into the heat-retaining stone or soapstone cowling, thus making room heating even more efficient.



Heta A/S stoves can also be equipped with a thermastone. The thermastone constitutes extra heat storage and makes room heating more efficient than an ordinary stove.



Integrated accessories deliver functionalities exclusive to Heta A/S stoves. A set of wood-burning fireside tools (brush, pan and poker) is included.



Eco-friendly and future-proof heating! All Heta A/S stoves meet the current requirements of BImSchV (the German Federal Emissions Control Act), and are approved in accordance with EN 13240/ EN13229, §15a BVG (Austria), BStV Regensburg, BStV München, and the Stuttgart and Aachen provisions.



Exceeds all regulatory requirements: Our CLEAN BURN+ stoves already score top marks for eco-friendliness. Our stoves have a very low noise level and CO₂ emissions that are at least 50 % lower than the strictest requirements, i.e. the current version of BImSchV, level 2, which comes into force in 2015.



Overview of technical data. All the technical data is available at the back of the main catalogue.



The Heta A/S quality assurance system is certified in Germany in accordance with SO ZERT DIN ISO 9001. The Heta A/S management policy is to maintain high standards of quality. Customer satisfaction is an important factor in our company policy. Our motto is: "It is better to act than to react".



We care about the environment. We introduced an environmental management system several years ago, and it is now certified in Germany in accordance with the applicable ÖKO ZERT DIN ISO 14001 standard. We strive consistently to improve on our excellent environmental record and achieve measurable results.



Our stoves are CE-marked, confirming that Heta A/S' products conform to the following EU norms and provisions: EN 13240/ EN13229, §15a BVG (Austria), BStV Regensburg, BStV München, and the Stuttgart and Aachen provisions.



UK Defra smoke exemption approved.

* Excludes Classic Inserts, Panoramas, Scan-Line 95, Scan-Line 100.

Contents

Scan-Line Craft	4-5
Scan-Line 800	6-15
Scan-Line 7, 70	16-19
Scan-Line Oura, Oura ceramic	20-23
Scan-Line 500 Turin and Napoli	24-28
Scan-Line 95, 100.....	29
Inspire 40, 45, 55	30-32
Kosi 6304.....	33
About Heta.....	34-35
Scan-Line Panorama inset stove.....	36
Scan-Line 550 inset stove and Classic.....	37-38
Scan-Line Tour 10, 20, 30.....	39
Scan-Line 80, 80XL	40-41
Scan-Line 10, 20, 30, 40, 50	42-43
Scan-Line 560	44
Enamel.....	45
Heta Automatic Combustion and glass floor panels.....	46-47
Thermastones.....	48-49
Ceramics, soapstone and sandstone.....	50-51
The Green pages	52-53
Technical info	54-59



Made in Denmark 



Scan-Line Craft
granite



Scan-Line Craft
sandstone

Scan-Line Craft series

The Craft series extends the already large Scan-Line 800 series. The extremely flexible combustion chamber – covering a broad spectrum from low-energy buildings up to 500 kg soapstone combinations with huge heat storage – allows for many innovative new designs. As the name suggests, Craft is a series of wood-burning stoves which offers extremely customised solutions.



Scan-Line Craft
black Shanxi granite



 **Heta**

Made in Denmark 

Scan-Line Craft series

Cladding options range from Tobacco sandstone to grey brushed Granite or high-gloss polished Shanxi granite. For all cladding types, storage rooms or small benches are also available, which can be configured to meet specific requirements. Granite cladding has extremely high mass, allowing it to store a lot of heat and slowly release it into the room.



Scan-Line Craft
black Shanxi granite



*Scan-Line 810
soapstone*



*Scan-Line 820B
soapstone*



*Scan-Line 820S
soapstone*



*Scan-Line 820W
soapstone*



*Scan-Line 830S
soapstone*



*Scan-Line 840W
soapstone*



*Scan-Line 840S
soapstone*



*Scan-Line 840B
soapstone*

Scan-Line 800 series

Scan-Line 800 is an elliptical stove in a stylish, modern design. Most of the visible surfaces are made in cast iron. Scan-Line 800 is both eco-friendly, elegant and practical. These stoves are a stylish and sculptural addition to any home.

The Scan-line 800 series comprises of six different variants at different heights. The models can of course be supplied with steel, soapstone or ceramic to meet individual customer requirements. The standard product programme also includes options for accumulating large volumes of heat, an enamelled baking oven, swivel models and combustion chambers at different heights.



Scan-Line 820B
soapstone



 **Heta**

Made in Denmark 

Scan-Line 820B

Scan-Line 820B with a baking oven and full soapstone combines the practical benefits of a baking oven with the unbeatable heat-accumulating properties of soapstone. Both baking oven and soapstone help retain the heat in the combustion chamber, and the result is amazingly efficient fuel combustion.



Scan-Line 800
soapstone



Scan-Line 850
soapstone



*Scan-Line 820S
ceramic
Indigoblau 1820*



*Scan-Line 820S
ceramic
Tabasco 302*



*Scan-Line 820S
ceramic
Schiefergrau dunkel 960*



*Scan-Line 820B
ceramic
Cognac 0460*



*Scan-Line 820B
ceramic
Salbei 1260*



*Scan-Line 820B
ceramic
Marone 1190*

Scan-Line 800 series

All the models in the Scan-Line 800 range are available with a ceramic surface and there are 42 Heta ceramic colours to choose from. Heta provides you with a unique opportunity to adapt the stove to bring a personal touch to your home interior.



Scan-Line 850
ceramic Seidenmatt weiß 495



 **Heta**

Made in Denmark 

Scan-Line 850

Scan-Line 850 Ceramic on a rotary column allows you to enjoy the flames and the elegant ceramic decoration from different angles. The ceramic is filled with chamotte. It disperses heat gradually over several hours after the stove itself has burned out.



Scan-Line 800
Brillantweiß 0010



*Scan-Line 800
sandstone top
Tobacco*



*Scan-Line 800
complete sandstone
Tobacco*



*Scan-Line 810
complete sandstone
Tobacco*



*Scan-Line 820B
complete sandstone
Tobacco*



*Scan-Line 830S
sandstone top
Tobacco*



*Scan-Line 800
sandstone top
Wenge*



*Scan-Line 820S
complete sandstone
Wenge*



*Scan-Line 820B
complete sandstone
Wenge*

The Scan-Line 800 series with sandstone

The Scan-Line 800 series with sandstone is a delight to the eye. No matter if you choose “wenge” sandstone with its grey-brown striped structure, or “tobacco” sandstone with its beige primary colour with the many interesting growth rings.

The noble sandstone from the Himalayas is cut, polished and protected for many years through a special treatment. An outstanding quality for all who values elegance.



Scan-Line 850
complete sandstone Tobacco



 **Heta**

Made in Denmark 

Scan-Line 850





Scan-Line 800



Scan-Line 810



Scan-Line 820B



*Scan-Line 820S
soapstone top*



Scan-Line 820W



*Scan-Line 830S
soapstone top*



Scan-Line 840S



*Scan-Line 840B
soapstone top*



Scan-Line 850



Fireside tool set



*Accumulation
Scan-Line 830S*

Scan-Line 830S
soapstone top



 **Heta**

Made in Denmark 

Scan-Line 830S



Scan-Line 800
soapstone top



Scan-Line 850
soapstone top



Scan-Line 820S
with side windows



Scan-Line 820B
with side windows



Scan-Line 800
with side windows

Scan-Line 800 series with side windows

The Scan-Line 800 and Scan-Line 820 models are now also available with side windows. This means that you can view the flames from different sides of the stove, making your stove an even more stylish, sculptural element in your home. And of course this stunning look is achieved without compromising the stove's perfect combustion qualities.



Scan-Line 850
wall-hung soapstone top Wenge



 **Heta**

Made in Denmark 

Scan-Line 850



Scan-Line 850
wall-hung



*Scan-Line 7B
with woodstore*



*Scan-Line 7B
complete soapstone*



Scan-Line 7B



*Scan-Line 7B
sandstone top Tobacco*



*Scan-Line 7B
soapstone top*



Scan-Line 7A

Scan-Line 7 series

With its compact modern design, the Scan-Line 7 series is truly stunning. The market's most flexible compact stove can be used in a variety of ways: as a conventional steel stove and in combination with either soapstone or sandstone cladding. No matter which variant you choose, Scan-Line 7 is an attractive and robust solution.

If you wish to store fuel or similar beneath the stove, or if you simply want to raise the height of the combustion chamber, a woodstore is available for Scan-Line 7B.



Scan-Line 7B
complete sandstone Tobacco



 **Heta**

Made in Denmark 

Scan-Line 7B



8 litres ashpan
Scan-Line 7A + 7B



*Scan-Line 7C
wall-hung
soapstone top*



*Scan-Line 7C
wall-hung
sandstone top Tobacco*



Scan-Line 7D



*Scan-Line 7D
soapstone top
turnable*



*Scan-Line 7D
sandstone top Tobacco
turnable*

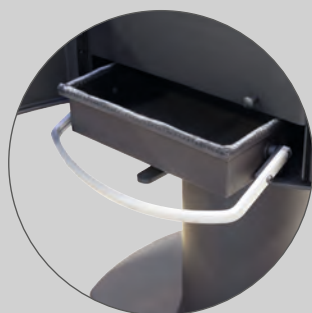

*3 litres ashpan
Scan-Line 7C + 7D*

Scan-Line 7 series

Several Scan-Line 7 variants can be wall-mounted, and others can be mounted on a column, which can also be supplied with a swivel function. The Scan-Line 7 series is adaptable and ideal for use in any interior. A combination of customary HETA quality with features, such as the perfect glass cleaning system and the patented ash pan system with a large cast-iron door, makes the Scan-Line 7 series first choice for modest heating requirements.

Scan-Line 7C
wall-hung



 **Heta**

Made in Denmark 

Scan-Line 7C





Oura 200



*Oura 200
soapstone top*



*Oura 200
soapstone*



*Oura 200
with side windows*



*Oura 200
soapstone top
with side windows*



*Oura 100
integrated swivel plinth
with side windows*

Oura series

Oura is the newest stove in the product range from Heta. It is a slim, smart designed wood-burning stove with a huge front glass, which gives a fantastic view to the flames. As an extra detail we have used aluminium handles and trims to give it the final touch.

The Oura series is available in many different options which include the choice of steel, soapstone, granite and coloured ceramic side panels and the option of side windows when fitted with steel sides.



Oura 200
with side windows



 **Heta**

Made in Denmark 

Oura 200



Oura 300
thermastone
with side windows



Oura 300 thermastone,
soapstone top
with side windows



*Oura 200
ceramic
White 2*



*Oura 200
ceramic
Light blue 13*



*Oura 200
ceramic
Green 11*



*Oura 200
ceramic
Black 4*



*Oura 200
ceramic
Cappuccino 9*



*Oura 200
ceramic
Red glossy 5*

Oura ceramic

The stylish Oura stoves are available in 13 splendid modern ceramic colours, allowing them to be uniquely customised to the user's taste.

Oura models can also be supplied with a stylish and modern high-gloss Shanxi granite finish, resulting in a very exclusive look.







Oura 200
ceramic Nougat 8



 **Heta**

Made in Denmark 

Oura 200

 80%	 4-10 kW	 30-120 m ²	 118,2cm	 24H	
---	--	--	---	---	---



Oura 200 black Shanxi granite



Shanxi granite



*Scan-Line 520W
ceramic
Basaltgrau 1420*



*Scan-Line 520B
ceramic
Indigoblau 1820*



*Scan-Line 520B
ceramic
Rot glänzend 303*



*Scan-Line 510
ceramic
Karmesinrot 2340*



*Scan-Line 500
ceramic
Ingwer 1180*



*Scan-Line 520B
ceramic
Schiefergrau dunkel 960*

Scan-Line 500 series

The Scan-Line 500 series is based on the steel models, available in 8 different versions. These are supplemented by versions with soapstone tops or complete soapstone cladding, and ceramic models in 42 colours, which can be freely combined.



Scan-Line 520B
ceramic Schiefergrau dunkel 960



 **Heta**

Made in Denmark 

Scan-Line 520B

-  81%
-  3-8 kW
-  30-95 m²
-  121 cm
-  24H
-  8l
- 
-  120° - 180°
- 

 CLEAN[™]
BURN



Scan-Line 520W
soapstone top



Scan-Line 510
complete soapstone



Scan-Line 520B
complete soapstone



Scan-Line 520B
complete soapstone

Scan-Line 520B

Naturally the Scan-Line 500 series meets all current regulatory requirements, thanks to the latest clean burn combustion technology. The special design of combustion air circulation means that the glass is always clean.



Scan-Line 500
complete soapstone





Made in Denmark 

Scan-Line Turin, Napoli

Scan-Line Turin and Napoli are Heta classics, with generous soapstone and ceramic cladding and the best combustion and ease-of-use on offer. Turin and Napoli are available in Heta's entire ceramic range, and colours can be mixed on the stoves in any combination desired. The ellipse-shaped tiles give the stoves an attractive appearance and the soapstone varieties are very heavy and solid, providing extensive heat storage.



Scan-Line Turin baking oven
soapstone



Scan-Line Napoli
soapstone

Scan-Line 500



Scan-Line 551

Scan-Line 500

With its unmatched combustion and large curved doors providing a panoramic view of the flames, Scan-Line 500 is the obvious choice of stove for any home. The combustion chamber is large and deep with space for plenty of fuel.





*Scan-Line 95
turnable pedestal*



*Scan-Line 100
pedestal*



*Scan-Line 100
without base*



Made in Denmark 

Scan-Line 95, 100

The Scan-Line 95/100 perfectly combines ultra-modern design with a panoramic view of the flames behind the wide glass front. Placed on a column, the large combustion chamber seems almost to float on air. The Scan-Line 95/100 can be supplied with an integrated swivel plinth so that you can spread the heat and mesmerising fire exactly where you want it.

Using ground-breaking combustion technology, the stoves provide amazingly clean and vibrant combustion, no matter what kind of fuel you burn.



Scan-Line 100R

80%	3-15	30-120		+
81%	5-15	60-175	24H	



Inspire 40 is a portrait stove suitable for installation into a fireplace or freestanding situation. A large cast iron door maximises the view of the fire creating a stunning impression in your home. A discreet single lever air control allows optimal combustion throughout the 2 – 6kW output range for tranquility and pleasure.



Inspire 45 is a wide landscape model with the same generous view of the flames. The combustion chamber can take logs up to 42cm and has an efficiency of 84%. It shares the same precise air control as the Inspire 40 throughout its 2.5 – 6.5kW output range.

*Inspire 45
enamel Majolica brown 6*



Inspire series

Heta's Inspire series is a range of rugged multi-fuel stoves made from the best quality 5mm and 8mm steel, with a solid cast iron door, fire base and shaker grate. Inspire stoves produce 2 – 6.3 kW of heat making them ideal for a wide range of applications from log cabins, country cottages, town houses to larger modern homes.

The simple single control makes them very easy to operate and combustion performance is excellent from as low as 2.5kW. The cast-iron doors for the Inspire series are available with a traditional black painted surface, but you can add extra style to your stove by choosing one of Heta's nine modern enamel colours.

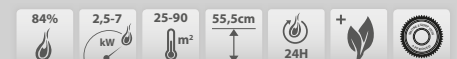



 **Heta**

Made in Denmark 

Inspire series

As an option, Inspire stoves can be mounted on a 32cm log store giving the stove a more prominent presence in the room. This convenient addition not only provides the option to store logs, but also enables the operation and re-fueling of the stove from a more comfortable level.

Inspire models can be installed with either a top or rear flue outlet. The inlet provided can also be used to supply direct outside air for combustion. The stoves are covered by a five year warranty.



Inspire 45
with log store



Inspire 55H

Inspire series

The Inspire 55 is the larger brother to the Inspire 40 and 45 and offers a wide view of the fire burning brightly in the fire chamber. A clean lined and beautifully made stove providing lots of heat for larger rooms. Load up to 50cm logs and be enchanted by the swirling and dancing flames leaving the large glass window crystal clear. A single lever air control gives remarkable control of the fire to ensure optimum clean burning performance. Choose 9 different enamel door colour options to customise the stove to your individual room requirements. An integrated log store option raises the stove making it perfect for open plan rooms and for easier loading.





Made in Denmark 

Kosi 6304

Charming, nostalgic, rustic but entirely delightful, the Kosi 6304 5kW multi fuel stove is the one of the oldest stoves in the Heta stove range. Built completely from cast iron but updated to include the latest in Heta patented clean burn technology to give a fantastic 82% efficiency. Install it freestanding or in a fireplace and enjoy the flames through the large window whilst enjoying the wonderful radiant warming heat that the stove produces. Fitted with 100mm legs as standard or 250mm long legs can be offered as an option. Finished in matt black as standard with multiple enamel colour finishes available.



Kosi 6304
enamel
Blue 9

Functionality and comfort ...

Heta A/S is a family-owned manufacturing company, based in Lemvig on the west coast of continental Denmark. Heta stoves are designed, developed and manufactured in Lemvig. The company's production facilities are state-of-the-art. At Heta we strive continually to modernise and adapt in line with our constantly changing and comprehensive range of Heta stoves. Even in these modern times, traditional craftsmanship and professional pride remain key company values, and innovative and highly functional stoves are the result.

Modern technology, specially selected high-quality materials, robust construction, leading-edge tooling and a modern and yet timeless aesthetic design are the key values in Heta's superior range of modern wood-burning stoves.

No stove ever leaves the factory in Lemvig without having undergone comprehensive production and quality assurance. From time to time, Director Carsten Bach and Factory Manager Martin Bach make spot checks personally.

Heta stoves are certified in accordance with the German ISO ZERT DIN ISO 9001 quality management system which guarantees that we maintain the highest quality standards. Customer satisfaction is the most important goal in our company policy.

We focus strongly on the environment and our common future. After years of working

intensively to produce eco-friendly, clean burning stoves with low environmental impact, we have now achieved environmental certification in accordance with ÖKO ZERT DIN EN ISO 14001. By making continual improvements and introducing solutions and concepts with respect for the environment, we achieve measurable results.

Every Heta employee turns in for work each day committed to maintaining and strengthening Heta's position in this regard. Maintaining and strengthening Heta's position as the leading supplier of Danish-made stoves is an important challenge.

Our stoves incorporating CLEAN BURN combustion technology are high-quality products made in Denmark. By utilising modern combustion technology, our stoves achieve especially high combustion efficiency. The technology also prevents soot particles from adhering to the glass door and flues. As soon as the stove is lit, healthy and comfortable radiant heat emanates from large glass doors. Soon after, the convection system begins to distribute heat and atmosphere into the room and adjacent rooms. Many of our products feature heat-retaining stones. Once heated, the stones remain warm for hours and slowly give off heat through the stove.

Heta stoves carry a 5-year guarantee.



Lemvig





5 Year warranty



Cast iron base and grate



Danish Quality



Ceramics



Outdoor air connection



Product range

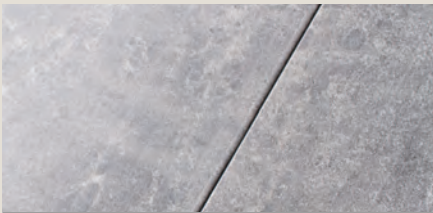

Soapstone



Cast iron door



Clean Burn



Sandstone



Fireside tool set



Ashpan



Granite



Enamel



Baking oven



Made in Denmark 

We design our wood-burning stoves with insight and respect for craftsmanship

A wood-burning stove must fulfil many needs. It must heat the home, look good in the room and be environmentally sound. And of course on a cold day it must keep you warm and cosy.

For us, design is more than look and style. It is about finding new ways and creating a harmony between form and function. A harmony that means your Heta stove brings pleasure every day for years to come.





 Heta



Panorama series

Heta Panorama inset stoves are elegant and modern insets, providing an extraordinarily fine view of the fire. The glass front is extremely stylish. Onlookers get a distinct impression that they are looking at a work of art.

Panorama inset stoves are simple to use. The beautiful and discrete integrated handle is convincing evidence of Panorama's quality and convenience.

Both Panorama inset models are available with specially-designed front panels, allowing the customer to give their inset a personal touch.



Panorama XL



 **Heta**

Made in Denmark 

Scan-Line 550

A portrait inset stove of the highest quality in a new design.



Scan-Line Classic 1
inset stove



Scan-Line Classic series

Classic design and clean lines for the modern designed home, with panoramic glass that emphasises the look.



Scan-Line Classic 2
inset stove



Scan-Line Tour 30
Brilliantweiß 0010



Scan-Line Tour 20
Schwarz glänzend 300



Scan-Line Tour 10
Schwarz glänzend 300

 **Heta**

Made in Denmark 

Scan-Line Tour series

The new Scan-Line Tour 10, 20, 30 series is destined to become a talking point. The exclusive combination of the Scan-Line Compact 500 with Kaufmann Keramik's elegant design represents top-class quality to meet every customer's requirements. There is a conventional model with convection air regulation. The Scan-Line Tour 30 can be fitted with extra accessories, e.g. extra heat storage in the form of 150 kg of thermastone.





*Scan-Line 80XL
ceramic
White glossy 1*



*Scan-Line 80
soapstone*



*Scan-Line 80
ceramic
White glossy 1*

Scan-Line 80, 80XL

The Scan-Line 80 and 80XL is based on Heta's popular Scan-Line 800 combustion chamber. This high-efficiency, user-friendly chamber offers great views of the large attractive flames. The combustion chamber also operates efficiently down to 2 kW output. The Scan-Line 80 and 80XL has solid soapstone or ceramic tiles which are easily mounted on the combustion chamber's steel housing. The large tiles result in a rugged yet very modern design, thanks to the cylindrical shape.



Scan-Line 80XL-B
soapstone



 **Heta**

Made in Denmark 

Scan-Line 80, 80XL

Heta's large patented ash drawer is concealed behind the lowest tiles, which slide out smoothly on rails and also provide access to a storage room. The Scan-Line 80XL comes with two large heat storage stones as standard. Together with the tiles these store heat for up to 18 hours after the last firing.

The Scan-Line 80 offers the same attractive qualities as its XL big brother, but with less heat storage. The Scan-Line 80 is ideal for settings with lower ceiling height, and is still a rugged stove made of heavy soapstone.



Scan-Line 80XL-B



Scan-Line 20



Scan-Line 20B



Scan-Line 30B



Scan-Line 10, 20, 30 series

Two stoves in one! The Scan-Line 10 / 20 / 30 stove combine the qualities of a wood-burning stove and a traditional thermal mass stove. This is a model that can be used as an ordinary wood-burning stove, and will heat a room up relatively quickly. Or you can close off the convection and use the thermal-mass principle, allowing the 500 kg of soapstone to slowly release the heat over many hours.



Scan-Line 10

81%	3-12	30-150	cm	126,1	152,3	178,5	24H	+



Heta

Made in Denmark 

Scan-Line 40, 50 series

Soapstone is well-known for its good quality to retain heat longer and gradually give off heat during a longer period. Scan-Line 40/50 is an alternative range to woodburning stoves/Thermal mass stoves. It is a timeless simple design where it is possible to regulate the convection airflow just above the door handle. When the convection air is turned off, the stoves changes from a convection to a traditional mass stove. The weight on this about 550 kg woodburning stove can be increased further by adding up to 100 kg thermastones.



Storage room

Scan-Line 560S



Scan-Line 560B

Scan-Line 560 series

Scan-Line 560S and 560B are our brand-new thermal mass stoves. They feature the same unique combustion system as the Scan-Line 500 range. Scan-Line 560S is supplied with three thermastones and Scan-Line 560B with baking oven is supplied with one thermastone. The thermastones absorb and then release heat gradually to ensure that you get most heat from your wood-burning or thermal mass stove.



Scan-Line 520B
enamel
Antique 2



1



2



3



4



Scan-Line 500
enamel
Blue 9



5



6



7



8



Scan-Line 800
enamel
Red 5



9



Made in Denmark 

Enamel

Heta customers can choose the type of enamel surface they want for their stoves. This is an exclusive choice of surface finishes that has been used with Heta wood-burning stoves for many years.

Enamelled surfaces have many advantages over traditionally-painted surfaces, e.g. the surface never changes or becomes scratched. Cleaning is easy as the surface is as smooth as glass, and also beautiful to look at.



Inspire 45
enamel
Red 5



Environment and economy:

Heta Automatic Combustion assists during firing in the stove by adjusting the airflow, thus ensuring that the stove always burns as efficiently and cleanly as possible. An optimum combustion means you utilize your firewood as much as possible and saves you up to 40%.



With an optimal combustion, you get not only more out of your burning. It will also ensure that polluting gases are burnt off before they leave the chimney. This benefits both the environment and your heating bill.



Heta Automatic Combustion unit

Heta Automatic Combustion

With Heta Automatic Combustion, Heta makes it easy to burn correctly. The automatically controlled air supply means that you simply have to fill the wood in your stove to achieve an optimal and clean combustion. After filling, Heta Automatic Combustion tells you when to refill. The module can be set to three different temperature levels. When Heta Automatic Combustion has reached the selected temperature, the stove will burn efficient and clean, automatically.

With Heta Automatic Combustion, you get a detailed overview of the combustion. The module is built-in and has a freestanding display that gives you all the necessary information. Heta Automatic Combustion is available for the Scan-Line 500, 800 and 95.



Universal (3535-0102)

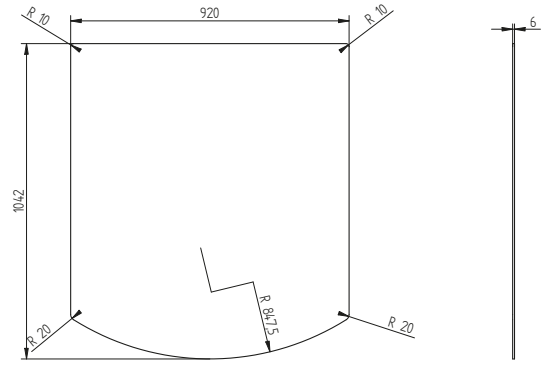

Scan-Line 800 (3535-0100)

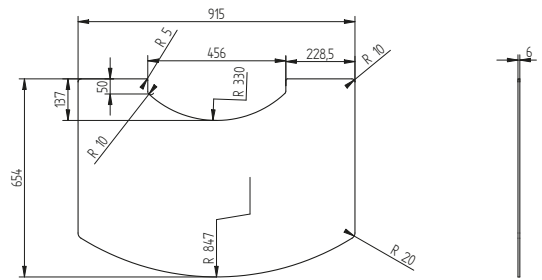

Scan-Line 500 (3535-0101)

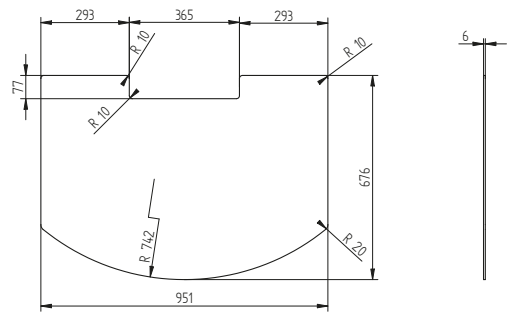

Made in Denmark 

Glass floor plates

With Heta's selection of glass floor plates, you get not only a nice touch to your stove, but at the same time protection for your floor from ashes and burn marks.

Glass plates from Heta are made of 6mm tempered glass and designed to withstand the heat and weight of the stove and chimney. The glass floor plates are available for Scan-Line 800 Scan-Line 500 series, as well as a universal glass.



Heta thermastones

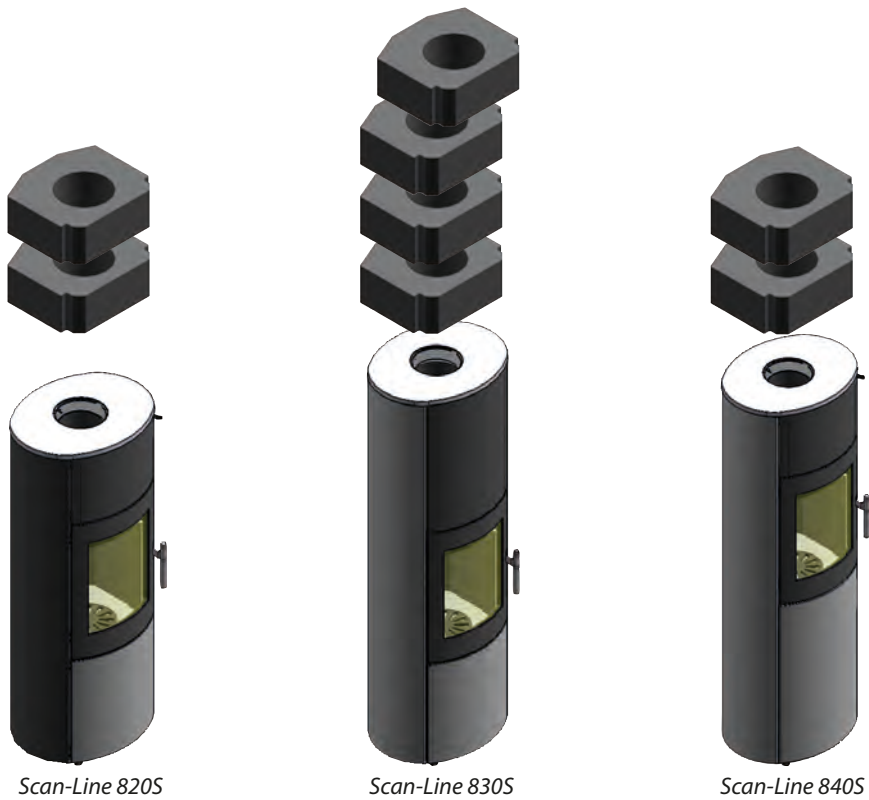
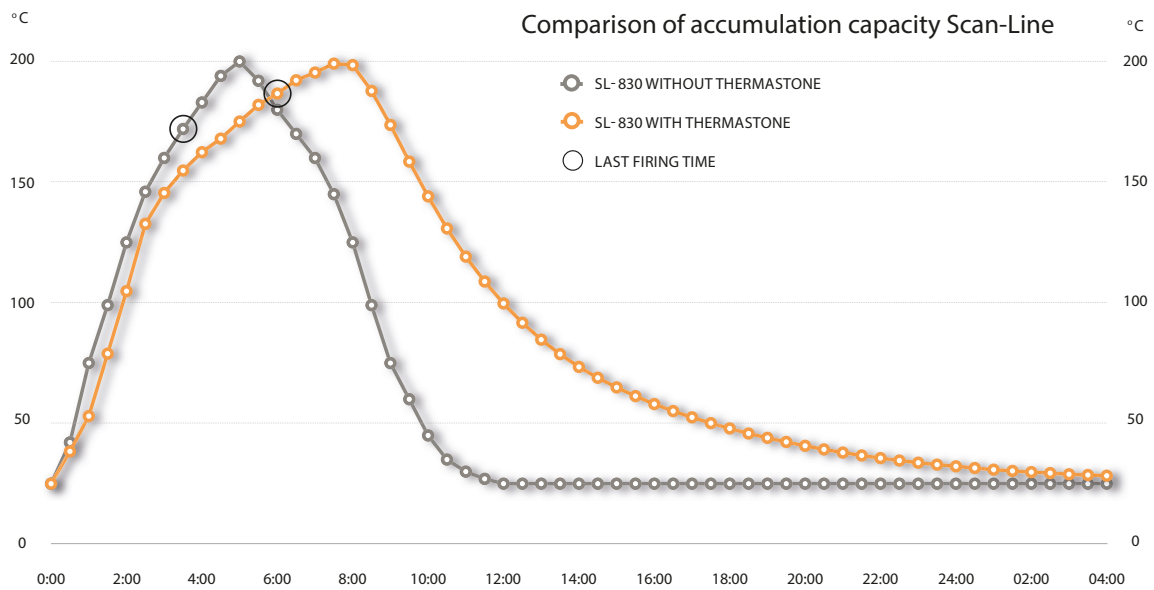

Thermastone
Scan-Line 830S

There are four different thermastones:

0023-0093 30 kg
Standard in SL 10, 20, 30, 40, 50

0023-0107 23 kg
Standard in SL 70, 520

0023-0108 12 kg
Standard in SL 500, 510, 550, 551

0023-0121 23 kg
Standard in SL 80XL, 820, 830, 840

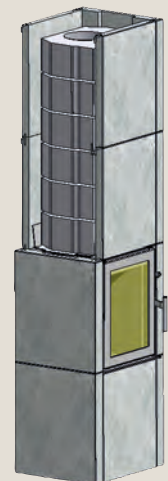

Thermastone
Scan-Line 50

	Always included:	Extra stones – purchase:
Scan-Line 10	1 unit (0023-0093)	2 units (0023-0108)
Scan-Line 20 low	2 units (0023-0093)	1 unit (0023-0093)
Scan-Line 20 high	1 unit (0023-0093)	2 units (0023-0108)
Scan-Line 20B	1 unit (0023-0093)	2 units (0023-0108)
Scan-Line 30	2 units (0023-0093)	1 unit (0023-0093)
Scan-Line 30 low	2 units (0023-0093)	3 units (0023-0093)
Scan-Line 30B low	1 unit (0023-0093)	1 unit (0023-0093)
Scan-Line 30B high	1 unit (0023-0093)	2 units (0023-0108)
Scan-Line 40	0	3 units (0023-0093)
Scan-Line 40B	0	1 unit (0023-0093)
Scan-Line 50	0	6 units (0023-0093)
Scan-Line 50B	0	4 units (0023-0093)
Scan-Line 80XL	2 units (0023-0121)	2 units (0023-0121)
Scan-Line 80XL-B	1 units (0023-0121)	0
Scan-Line 500	0	1 unit (0023-0108)
Scan-Line 510	0	1 unit (0023-0108)
Scan-Line 520	0	1 unit (0023-0107)
Scan-Line 520 complete soapstone	0	1 unit (0023-0107)
Scan-Line 550	0	1 unit (0023-0108)
Scan-Line 551	0	1 unit (0023-0108)
Scan-Line 560S	3 units (0023-0093)	0
Scan-Line 560B	1 unit (0023-0093)	0
Scan-Line 820S	2 units (0023-0121)	0
Scan-Line 830S	4 units (0023-0121)	0
Scan-Line 840S	2 units (0023-0121)	0
Scan-Line Tour 10	0	1 unit (0023-0093)
Scan-Line Tour 20	0	2 units (0023-0093)
Scan-Line Tour 30	0	5 units (0023-0093)
Oura 300	1 unit (0023-0121)	0

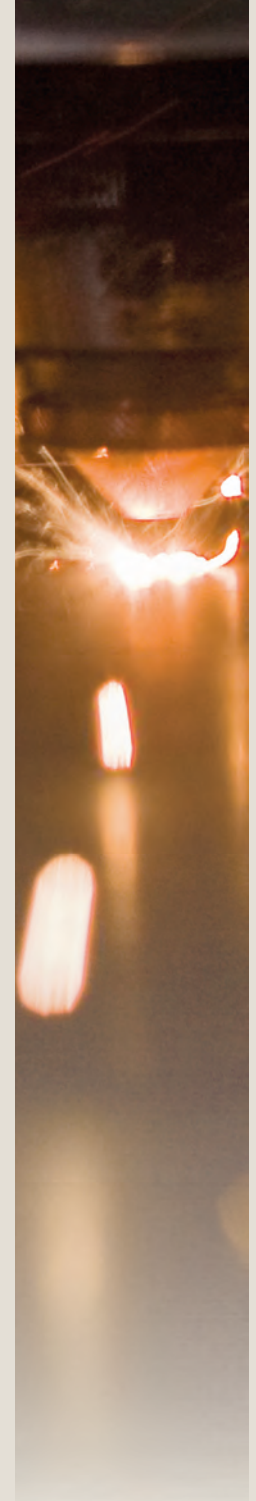

Made in Denmark 

Overview of thermastones for the Scan-Line series

Dreaming of accumulating heat from a wood-burning stove over several hours? With HETA stoves your dream comes true! Depending on your choice of model, there is space for up to six thermastones, which make it possible to store heat while regulating or even shutting off convection air flow. Our thermastones are made of a special cement-based material that absorbs heat extremely effectively and then releases it slowly over a longer period of time – Perfect in combination with fast-heating Heta stoves!



Kaufmann Ceramic

Only for Scan-Line 500, 800, Turin, Napoli and Tour

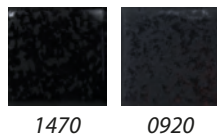

KeCera

Only for Oura

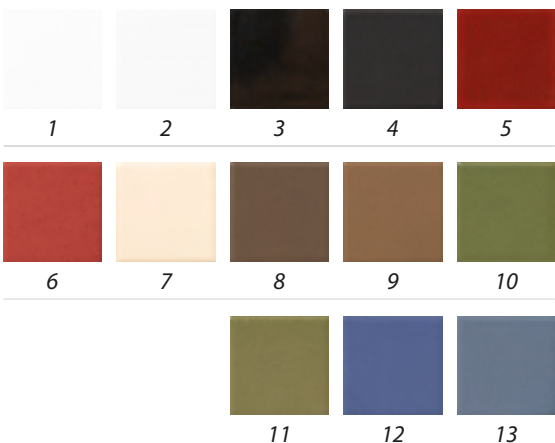

From concept to finished tile

1. A model is created using plaster or clay according to the designer's specifications.
2. An original mould (model shape) is produced with the model.
3. Following various tests and final shape acceptance, a plastic fitting is created, from which the actual moulds for production are then created.
4. The casting compound with its main clay ingredient made up of a watery aluminium silicate and fire clay, a fire-resistant material with 10 to 45 % aluminium oxide, then goes into the moulds. The mass remains in the moulds for approx. 12 hours until it has taken on a leathery consistency.
5. The tile is removed from the mould, and the edges and all unevenness are cleaned smooth with a sponge.
6. The tile then air-dries, before it is biscuit-fired in the first fire at relatively lower temperatures (pre-burnt).
7. The tiles are now given their elegant coating when the glaze is sprayed on.
8. All ceramic parts of a ceramic tile heater then go to the final fire at over 1100°C. All parts of the same consignment are burnt together to ensure there are absolutely no colour differences.
9. The quality controls follow in the sorting shop. If a part is defective, steps 4 to 9 are repeated. This means a tile's production time is approx. 14 days.
10. Packed up nice and safe, the tiles begin their journey to Denmark.
11. They are tiled onto the ordered ceramic tile heater model in the Heta plant, and off they go to the Heta dealer!

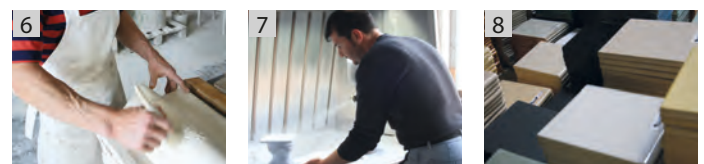



Sandstone

Sandstone is quarried in the Himalayas at about 2,900 m above sea level. The quarry is located in an area of stunning natural beauty. Even at this altitude, the climate is mild and it is possible to farm. The sandstone is brought down from the mountains on large lorries and transported 2,600 km to Xiamen, where it is loaded onto ships bound for Europe, where the stone is processed. In geological terms, sandstone is a

fine-grain natural stone product composed of quartz sand. The sand compacted over millions of years. Due to changing pressure conditions and different minerals in the earth's crust, there is often a fantastic play of colours in sandstone.



Scan-Line 820S
complete sandstone
Tobacco

Scan-Line 80XL Soapstone

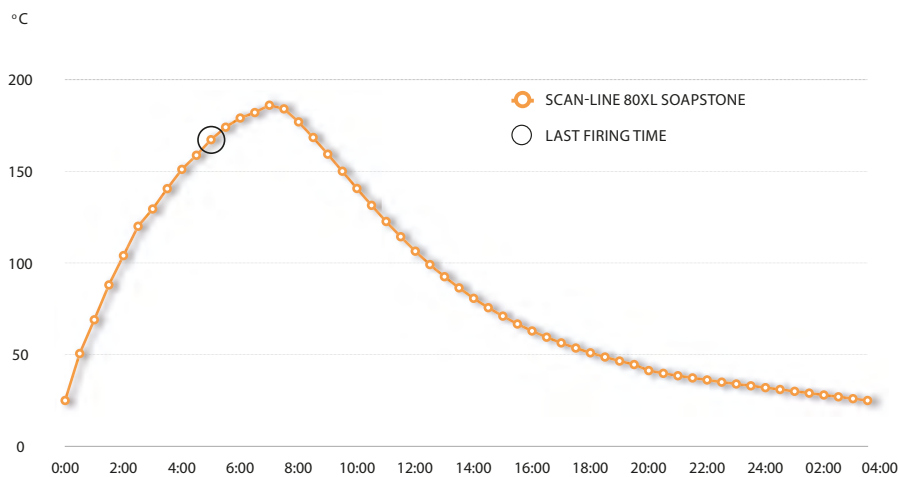

Soapstone

Soapstone is 3 billion years old – and perfectly timeless. Solid soapstone is fascinating to look at but also possesses more subtle qualities. A soapstone stove very efficiently retains the heat energy liberated when wood is burned. The soapstone then releases the heat very slowly and evenly in the room. If you fill the chamber just two or three times, the stove will keep the room heated for up to 14 hours, so you enjoy the comfort and benefits of the heat long after the fire has gone out.

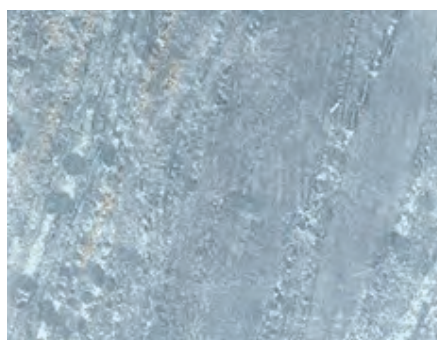

Quick guide

1. The installation has to be correct/done by a professional.
2. The chimney has to be approved. An oldstyle bricked chimney with a 24x24 cm flue cannot be used.
3. Never use damp firewood or a damp stove.
4. Never burn milk cartons, pressure-imprenated wood, magazines or newspapers.
5. Read the user instructions. Primary stoking should take 10-20 minutes to correctly warm up the stove and chimney.
6. Then you can use the stove as normal. But now use only secondary air/combustion air and close everything else: door, primary air, valve, ashpan, etc., so that only air from the top of the door/glass is used.
7. If glass panel and refractories turn black then there is insufficient air.
8. Feed the fire often, with small amounts of fire-wood. If you feed too much firewood into the fire, you will be inclined to turn the air supply right down, resulting in pollution.
9. Never leave the fire to burn overnight. It harms the environment as uncombusted gases escape through the chimney.

Drying firewood

All types of wood can be used. The firewood should be chopped and left to dry for one-to-two years under a rain cover, to achieve a moisture content of approximately 18%. Remember, firewood absorbs some moisture during winter.

All types of wood have approximately the same calorific value per kilogram. Oak and beech are dense and therefore heavier, and so have a higher calorific value per cubic meter. Fir tree is light and so has less calorific value per cubic meter.

Maintenance

Wood-burning stove surfaces with a heat-resistant paint: clean with a damp cloth. If the varnish becomes damaged you can buy varnish in a spray can and repair the damage.

Cleaning the glass

If the wood is not sufficiently dry, the combustion temperature will be too low. The wood will smoulder instead of burning, causing soot to accumulate on the glass. If the glass has to be cleaned, use ordinary window cleaner or if needed, use special glass cleaner from a dealer. You can also remove the soot by rubbing ash around the glass with a piece of wet kitchen roll.

Repairing and cleaning soapstone

Soapstone is a naturally soft type of stone. You can repair scratches or surface damage with fine P120 sandpaper, but you should be careful.

Dirty surfaces (soot, grease, etc.) should be cleaned with water and mildly-acidic soap.

- the soap should be applied to the surface
- leave it for a couple of minutes
- wash the surface with warm water
- when the surface is dry, if needed you can sand it down with fine sandpaper.

Combustion cycle

Unlike fossil fuels (oil, coal and gas) burning wood is CO₂ neutral and therefore does not add to the overall greenhouse gas effect.

There is no difference in the amount of CO₂ released from a piece of burned firewood than a piece left to rot in a wood.

As trees grow, they absorb CO₂ with help from the sun's energy, and unlike fossil fuels, only return the same amount of CO₂ that was absorbed, thus they do not contribute to global warming or the greenhouse effect.



Choosing your wood-burning stove

There is a huge range to choose from, but choosing a wood-burning stove is not so simple. Before you decide, ask yourself the following four questions:

1. Where will you place it?

Is your wood-burning stove to be the primary source of heating or will it just provide a cosy fire-lit atmosphere in your home? The answer is crucial for your choice of wood-burning stove. A wood-burning stove's heat output is measured in kilowatts (kW). It is an expression of the amount of heat given out by a stove. As a rule-of-thumb, 1 kW can warm up a 10-20m² room of average-height ceiling (depending on the room's insulation). The value "kW tested" shows a stove's output has been tested in accordance with the European Committee for Standardisation's EN standard.

2. Radiation or convection?

The majority of new stoves use convection, where air is circulated between an inner and outer steel mantle. When the air is heated, it rises and warms the room. The convective heat from a wood-burning stove warms evenly, but requires a stove to be placed physically closer than a radiating stove.

3. Plate steel or cast iron?

Both kinds of materials make excellent wood-burning stoves and recessed fireplaces. Heta wood-burning stoves have cast iron doors and bottom grates, so they remain tightly sealed and longlasting.

4. Steel, ceramic or soapstone?

Heta supplies steel or cast iron stoves. Ceramic, soapstone, enamel or chamotte options are available. The choice of material is a matter of style and taste, though each material has particular characteristics. A stove made entirely from steel or cast iron warms up faster than a ceramics or soapstone stove. But it also cools faster when the fire has gone out. Ceramics and especially soapstone take a little longer to warm up, but stay warm long after the fire has gone out. The slightly larger soapstone stoves stay warm for many hours and can easily keep a room or house nice and warm through the night, so you will not wake up cold in the morning.

5. Combustion technique

Heta stove uniquely-designed fireboxes and air supply reduce CO and harmful combustion particles to an absolute minimum.

Heta stoves use pre-heated combustion air for a clean burn (blue arrow), i.e. the combustion air is free-flowing and feeds combustion without any resistance.

The pre-heated tertiary air supply (green arrow) combusts the remaining gases before the smoke vent up the chimney: a crucial factor in environmentally-friendly combustion.

The warmed convection air (red arrow) flows across the room, which along with the infra-red heat from the glass front is what warms the room. This makes the stove's heat efficient and means you can enjoy looking at the flames of your fire – soot-free.

Umweltausweis		Ihre Produkt von Heta	
Feinstaub-Anforderung <small>Minimale Anforderungen</small> A B C D E (Scale with A at top, E at bottom)	Erfüllt:	Umweltklasse	A
CO-Anforderung <small>Minimale Anforderungen</small> A B C D E (Scale with A at top, E at bottom)	Erfüllt:	Umweltklasse	A
Wirkungsgrad-Anforderung <small>Minimale Anforderungen</small> A B C D E (Scale with A at top, E at bottom)	Erfüllt:	Umweltklasse	A
Dauerbetrieb möglich	Ja	Filter erforderlich	Nein
Messung erforderlich	Nein		

Heta A/S • Jupitervej 22 • DK-7620 Lemvig • www.heta.dk

Red arrows:
convection air

Green arrows:
tertiary air











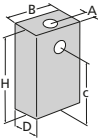

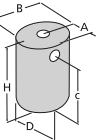

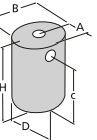

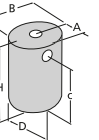
Blue arrows:
combustion air

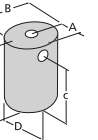

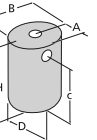

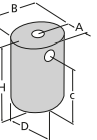

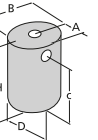

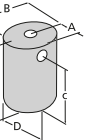











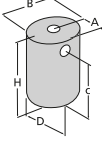
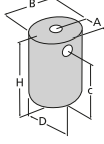
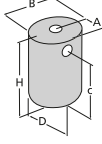
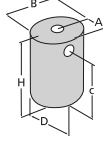
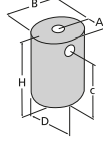
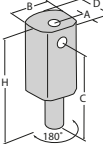
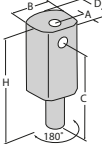
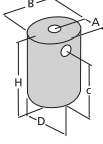
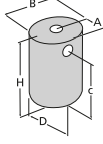
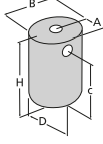

Made in Denmark 









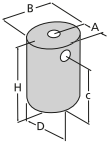
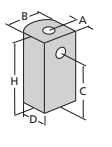
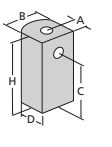
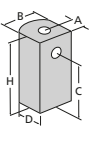
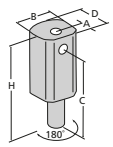
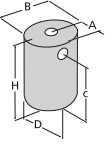
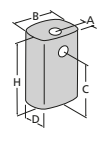
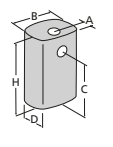
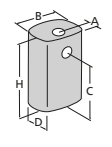











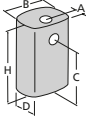
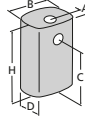
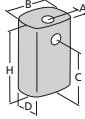
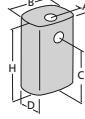
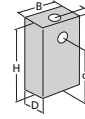
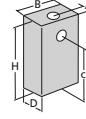
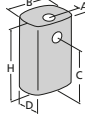
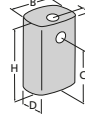
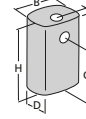
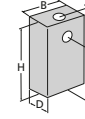



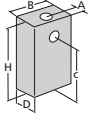

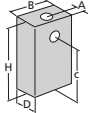

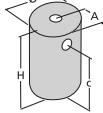
Technical info

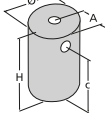

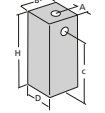

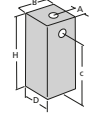

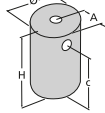

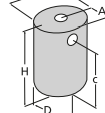

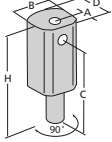

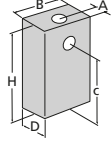

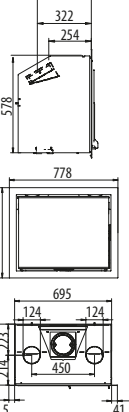

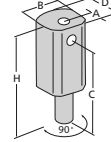
Stove type	Scan-Line Craft Granite / Sandstone	Scan-Line 800	Scan-Line 800 Ceramics / Soapstone / Sandstone	Scan-Line 810	Scan-Line 810 Ceramics / Soapstone / Sandstone	Scan-Line 820 / 820S / 820B	Scan-Line 820 / 820S Ceramics / Soapstone / Sandstone	Scan-Line 820B Ceramics / Soapstone / Sandstone	Scan-Line 830S
	 	 	 	 	 	 	 	 	 
mm	A: 214 B: 574 C: 880 D: 440 H: 1155	A: 214 B: 548 C: 897 D: 440 H: 1043	A: 218 B: 560 C: 897 D: 445 H: 1075	A: 214 B: 548 C: 1179 D: 440 H: 1325	A: 218 B: 560 C: 1179 D: 445 H: 1325	A: 214 B: 548 C: 897 D: 440 H: 1325	A: 218 B: 560 C: 897 D: 445 H: 1357	A: 218 B: 560 C: 897 D: 445 H: 1357	A: 214 B: 548 C: 897 D: 440 H: 1607
Floor to top flue outlet	1004	1004	1004	1286	1286	1004 / 1295	1004	1295	1004
See picture on page(s)	4-5	6-15	6-15	6-15	6-15	6-15	6-15	6-15	6-15
Color	black / grey	black / grey	black / grey	black / grey	black / grey	black / grey	black / grey	black / grey	black / grey
Nominal kW	5,5	5,5	5,5	5,5	5,5	5,5	5,5	5,5	5,5
Heat output kW	2-8	2-8	2-8	2-8	2-8	2-8	2-8	2-8	2-8
Est. room size m2	25-95	25-95	25-95	25-95	25-95	25-95	25-95	25-95	25-95
Outlet pipe size Ø mm	150	150	150	150	150	150	150	150	150
Weight kg	237 / 213	113	134 / 200 / 174	130	155 / 238 / 209	127 / 177 / 142	153 / 235 / 206 203 / 285 / 256	168 / 250 / 221	235
Fuel volume kg	1,5	1,5	1,5	1,5	1,5	1,5	1,5	1,5	1,5
Combustion chamber width mm	330	330	330	330	330	330	330	330	330
Min. draught	0,13	0,13	0,13	0,13	0,13	0,13	0,13	0,13	0,13
Distance to flammable materials mm									
At the sides	300	300	300	300	300	300	300	300	300
Behind stove	125	125	125	125	125	125	125	125	125
Distance to furniture									
mm	900	900	900	900	900	900	900	900	900
CO % / mg / m3	0,07 / 877	0,07 / 877	0,07 / 877	0,07 / 877	0,07 / 877	0,07 / 877	0,07 / 877	0,07 / 877	0,07 / 877
Efficiency %	79	79	79	79	79	79	79	79	79
Dust-messurement NS3058 g/kg	2,61	2,61	2,61	2,61	2,61	2,61	2,61	2,61	2,61
Dust-messurement EN13240 g/kg	18	18	18	18	18	18	18	18	18
Flu/gas/ g/sec	5,3	5,3	5,3	5,3	5,3	5,3	5,3	5,3	5,3
Flu/gas temperature C°	274	274	274	274	274	274	274	274	274
NOx mg/m3n	98	98	98	98	98	98	98	98	98

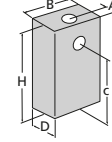
Scan-Line 830S Ceramics / Soapstone	Scan-Line 840 / 840S / 840B	Scan-Line 840 / 840S / 840B Ceramics / Soapstone	Scan-Line 850	Scan-Line 850 Ceramics / Soapstone / Sandstone	Scan-Line 850 Turnable	Scan-Line 850 Turnable Ceramics / Soapstone / Sandstone	Scan-Line 850 / wall-hung / Ceramics / Soapstone / Sandstone	Scan-Line 800 Side windows	Scan-Line 820 / 820S Side windows
									
									
A: 218 B: 560 C: 897 D: 445 H: 1639	A: 214 B: 548 C: 1179 D: 440 H: 1607	A: 218 B: 560 C: 1179 D: 445 H: 1639	A: 214 B: 548 C: 872 D: 440 H: 1035	A: 218 B: 560 C: 872 D: 445 H: 1067	A: 214 B: 548 C: 885 D: 440 H: 1048	A: 218 B: 560 C: 885 D: 445 H: 1080	A: 242 B: 548 / 560 C: 516 D: 468 / 469 H: 682 / 711	A: 214 B: 548 C: 897 D: 440 H: 1043	A: 214 B: 548 C: 897 D: 440 H: 1325
1004	1286 / 1577	1286 / 1577	996	996	1013	1013	640	1004	1004
6-15	6-15	6-15	6-15	6-15	6-15	6-15	6-15	6-15	6-15
black / grey	black / grey	black / grey	black / grey	black / grey	black / grey	black / grey	black / grey	black / grey	black / grey
5,5	5,5	5,5	5,5	5,5	5,5	5,5	5,5	6	6
2-8	2-8	2-8	2-8	2-8	2-8	2-8	2-8	3-10	3-10
25-95	25-95	25-95	25-95	25-95	25-95	25-95	25-95	30-125	30-125
150	150	150	150	150	150	150	150	150	150
266 / 366	147 / 197 / 159	178 / 278 / 190 228 / 328 / 290	110	117 / 166 / 150	112	119 / 168 / 152	102 / 109 / 158 / 142	118	147 / 181
1,5	1,5	1,5	1,5	1,5	1,5	1,5	1,5	1,5	1,5
330	330	330	330	330	330	330	330	330	330
0,13	0,13	0,13	0,13	0,13	0,13	0,13	0,13	0,12	0,12
300 125	300 125	300 125	300 125	300 125	300 125	300 125	300 125	450 130	450 130
900	900	900	900	900	900	900	900	850	850
0,07 / 877	0,07 / 877	0,07 / 877	0,07 / 877	0,07 / 877	0,07 / 877	0,07 / 877	0,07 / 877	0,066 / 824	0,09 / 1125
79	79	79	79	79	79	79	79	80	80
2,61	2,61	2,61	2,61	2,61	2,61	2,61	2,61	3,16	3,16
18	18	18	18	18	18	18	18	8	8
5,3	5,3	5,3	5,3	5,3	5,3	5,3	5,3	5,3	5,3
274	274	274	274	274	274	274	274	277	276
98	98	98	98	98	98	98	98	101	99

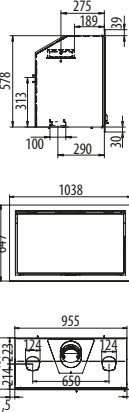
Stove type	Scan-Line 820B Side windows	Scan-Line 7A / 7B	Scan-Line 7B Sandstone / Soapstone	Scan-Line 7C	Scan-Line 7D / Turnable	Oura 100 / Side windows / Turnable	Oura 200 / Side windows / Steel / Soapstone / Ceramics / Granite	Oura 300 / Side windows	Scan-Line 500 / Ceramics / Soapstone
Technical info									
									
mm	A: 214 B: 548 C: 897 D: 440 H: 1325	A: 176 / 196 B: 404 / 462 C: 698 D: 394 / 415 H: 880	A: 197 B: 467 C: 698 D: 417 H: 910	A: 220 B: 462 C: 525 D: 440 H: 710	A: 196 B: 462 C: 883 / 896 D: 415 H: 1063 / 1076	A: 194 B: 543 C: 1030 D: 413 H: 1168 / 1181	A: 194 B: 543 C: 1030 D: 413 H: 1182	A: 194 B: 543 C: 1030 D: 413 H: 1444	A: 141 / 147 B: 504 / 570 C: 794 D: 468 / 498 H: 1010 / 1030
Floor to top flue outlet	1004	812 / 812	812	640	994 / 1013	1123 / 1142	1138	1138	930
See picture on page(s)	6-15	16-19	16-19	16-19	16-19	20-23	20-23	20-23	24-26, 28
Color	black / grey	black / grey	black / grey	black / grey	black / grey	black / grey	black / grey	black / grey	black / grey
Nominal kW	6	4	4	4	4	7	7	7	5
Heat output kW	3-10	2-6	2-6	2-6	2-6	4-10	4-10	4-10	3-8
Est. room size m2	30-125	20-80	20-80	20-80	20-80	30-120	30-120	30-120	30-95
Outlet pipe size Ø mm	150	150	150	150	150	150	150	150	150
Weigth kg	162	96	129 / 147	90	100 / 102	119 / 122	127 / 130 / 153 / 134 / 160	162 / 165	108 / 140 / 185
Fuel volume kg	1,5	1	1	1	1	1,85	1,85	1,85	1,6
Combustion chamber width mm	330	306	306	306	306	398,5	398,5	398,5	340
Min. draught	0,12	0,12	0,12	0,12	0,12	0,12	0,12	0,12	0,12
Distance to flammable materials mm									
At the sides Behind stove	450 130	100 100	100 100	100 Non flammable wall	100 100	600 / 450 100 / 150	600 / 450 100 / 150	600 / 450 100 / 150	430 160
Distance to furniture mm	850	800	800	800	800	850 / 1050	850 / 1050	850 / 1050	1050
CO % / mg / m3	0,09 / 1125	0,09 / 1125	0,09 / 1125	0,09 / 1125	0,09 / 1125	0,08 / 1060	0,08 / 1060	0,08 / 1060	0,08 / 1000
Efficiency %	80	83,1	83,1	83,1	83,1	80	80	80	81
Dust- messurement NS3058 g/kg	3,16	2,18	2,18	2,18	2,18	2,12	2,12	2,12	4,57
Dust- messurement EN13240 g/kg	8	20	20	20	20	11	11	11	19
Flu/gas/ g/sec	5,3	3,2	3,2	3,2	3,2	6,1	6,1	6,1	4,8
Flu/gas temperture C°	276	260	260	260	260	278	278	278	265
NOx mg/m3n	99	74	74	74	74	95	95	95	125

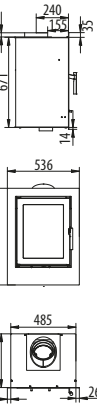
Scan-Line 510 / 520	Scan-Line 510 Ceramics / Soapstone	Scan-Line 520 Ceramics / Soapstone	Scan-Line 520B / Ceramics / Soapstone	Scan-Line 550 / 551	Scan-Line 560S / 560B	Scan-Line Napoli Ceramics / Soapstone	Scan-Line Turin Ceramics / Soapstone	Scan-Line Turin Bakeoven Ceramics / Soapstone	Inspire 40
									
									
A: 141 B: 504 C: 974 / 794 D: 468 H: 1190	A: 147 B: 570 C: 974 D: 498 H: 1210	A: 147 B: 570 C: 794 D: 498 H: 1210	A: 141 / 147 B: 504 / 570 C: 794 D: 468 / 498 H: 1190 / 1210	A: 148 B: 476 / 558 C: 921 D: 402 H: 1117	A: 148 B: 476 C: 921 D: 402 H: 1532	A: 157 B: 614 C: 836 D: 486 H: 1056	A: 157 B: 614 C: 836 D: 486 H: 1302	A: 157 B: 614 C: 836 D: 486 H: 1302	A: 113 B: 460 C: 467 D: 367 H: 585
1110	1110	930	1163	1058	1058 / 1291	972	972	1257	596
24-26, 28	24-26, 28	24-26, 28	24-26, 28	24-26, 28	42	27	27	27	30-31
black / grey	black / grey	black / grey	black / grey	black / grey	black / grey	black / grey	black / grey	black / grey	black / grey
5	5	5	5	5	5	5	5	5	4,9
3-8	3-8	3-8	3-8	3-8	3-8	3-8	3-8	3-8	2-6
30-95	30-95	30-95	30-95	30-95	30-95	30-95	30-95	30-95	20-80
150	150	150	150	150	150	150	150	150	125
115 / 121	152 / 214	141 / 205	134 / 165 / 229	117	234 / 191	142 / 213	180 / 262	186 / 268	74
1,6	1,6	1,6	1,6	1,6	1,6	1,6	1,6	1,6	1,1
340	340	340	340	340	340	340	340	340	370
0,12	0,12	0,12	0,1	0,12	0,12 / 0,1	0,12	0,12	0,1	0,13
430 160	430 160	430 160	300 200	430 160	300 / 430 200 / 160	430 160	430 160	430 160	340 120
1050	1050	1050	800	1050	800 / 1050	1050	1050	800	900
0,08 / 1000	0,08 / 1000	0,08 / 1000	0,09 / 1162	0,08 / 1000	0,08 / 1000 0,09 / 1162	0,08 / 1000	0,08 / 1000	0,09 / 1162	0,08 / 1049
81	81	81	81	81	81	81	81	81	81
4,57	4,57	4,57	4,57	4,57	4,57	4,57	4,57	4,57	2,86
19	19	19	34	19	19 / 34	19	19	34	27
4,8	4,8	4,8	6	4,8	4,8 / 6	4,8	4,8	6	3,7
265	265	265	270	265	265 / 270	265	265	270	263
125	125	125	87	125	87 / 125	125	125	87	90

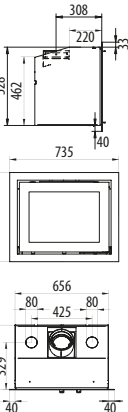
Stove type	Inspire 45	Inspire 55 / 55H	Scan-Line 10 / 20 / 30	Scan-Line 20B / 30B	Scan-Line 40 / 40B	Scan-Line 50 / 50B	Scan-Line Tour 10 / 20 / 30	Scan-Line 80 / 80XL / 80XL-B	Kosi 6304
	Technical info	 	 	 	 	 	 	 	 
mm	A: 116 B: 540 C: 451 D: 377 H: 555	A: 130 B: 652 C: 451 D: 403 H: 555 / 910	A: 264 B: 640 C: 1068 / 1330 / 1592 D: 640 H: 1261 / 1523 / 1785	A: 264 B: 640 C: 1330 / 1592 D: 640 H: 1523 / 1785	A: 205 B: 530 C: 916 / 1431 D: 450 H: 1605	A: 205 B: 530 C: 916 / 1431 / 1946 D: 450 H: 2120	A: 310 B: 620 C: 1298 / 1602 Rear outlet only D: 620 H: 1380 / 1684 / 1988	A: 302 B: 605 C: 1014 D: 585 H: 1217 / 1793	A: 151 B: 431 C: 708 D: 372 H: 801
Floor to top flue outlet	566	566 / 921	952	1186	1054 / 1287	1054 / 1287	978	1138 / 1138 / 1521	805
See picture on page(s)	30-31	32	42	42	43	43	39	40-41	33
Color	black / grey	black / grey	black / grey	black / grey	black / grey	black / grey	black / grey	black / grey	black / grey
Nominal kW	4,9	6,3	5	5	5	5	5	5,5	4,4
Heat output kW	2,5-7	4,5-10	3-12	3-12	3-10	3-10	3-12	2-8	2-6
Est. room size m ²	25-90	30-110	30-150	30-150	30-120	30-120	30-150	25-95	15-85
Outlet pipe size Ø mm	125	125	150	150	150	150	150	150	120
Weight kg	80	108 / 131	451 / 519 / 614	509 / 604	420 / 431	541 / 552	254 / 292 / 330	266 / 395 / 387	56
Fuel volume kg	1,2	1,5	1,6	1,6	1,6	1,6	1,6	1,5	1,1
Combustion chamber width mm	424	560	340	340	340	340	340	330	300
Min. draught	0,12	0,12	0,1	0,1	0,1	0,1	0,1	0,13	0,12
Distance to flammable materials mm									
At the sides	300	420	430	430	200	200	430	300	400
Behind stove	195 / 150	220 / 150	170	170	170	170	170	125	130 / 210
Distance to furniture									
mm	860	1200	900	900	800	800	900	900	800
CO % / mg / m ³	0,08 / 1052	0,1 / 1250	0,09 / 1162	0,09 / 1162	0,09 / 1162	0,09 / 1162	0,09 / 1162	0,07 / 877	0,085 / 1061
Efficiency %	84	80	81	81	81	81	81	79	82
Dust-messurement NS3058 g/kg	1,89	3,15	4,57	4,57	4,57	4,57	4,57	2,61	-
Dust-messurement EN13240 g/kg	13	28	34	34	34	34	34	18	17
Flu/gas/ g/sec	4	5,7	6	6	6	6	6	5,3	4,2
Flu/gas temperature C°	221	263	270	270	270	270	270	274	241
NOx mg/m ³ n	112	130	87	87	87	87	87	98	90

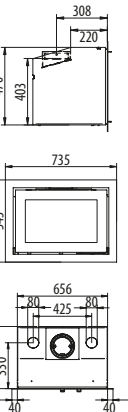
Scan-Line 95 / Option	Scan-Line 95 Whitout base	Scan-Line Panorama Inset stove	Scan-Line 100 / Option	Scan-Line 100 / 100S Whitout base	Scan-Line Panorama XL Inset stove	Scan-Line 550 Inset stove	Scan-Line Classic 1 Inset stove	Scan-Line Classic 2 Inset stove
 	 	 	 	 	 	 	 	 
A: 151 B: 760 C: 739 / 754 D: 433 H: 1007 / 1022	A: 151 B: 760 C: 331 D: 433 H: 599	A: 151 B: 1019 C: 742 / 758 D: 433 H: 1007 / 1022	A: 151 B: 1019 C: 334 D: 433 H: 599	A: 151 B: 1019 C: 334 D: 433 H: 599	A: 151 B: 1019 C: 334 D: 433 H: 599	A: 151 B: 1019 C: 334 D: 433 H: 599	A: 151 B: 1019 C: 334 D: 433 H: 599	A: 151 B: 1019 C: 334 D: 433 H: 599
943 / 961	540	-	883 / 901	475	-	-	-	-
29	-	34	29	29	34	35	36	36
black	black / grey	black / grey	black / grey	black / grey	black / grey	black / grey	black / grey	black / grey
6,5	6,5	6,5	9	9	9	5	6,4	6,4
3-9	3-9	3-9	5-15	5-15	5-15	3-8	3,5-10	3,5-10
30-120	30-120	30-120	50-150	50-150	50-150	30-95	30-130	30-130
150	150	150	150	150	150	150	150	150
145	122	112	169	146	145	93	94	88
1,9	1,9	1,9	2,3	2,3	2,3	1,6	1,7	1,7
548 / 462	548 / 462	548 / 462	808 / 730	808 / 730	808 / 730	340	510	510
0,13	0,13	0,13	0,13	0,13	0,13	0,12	0,12	0,12
350 150	350 150	- -	250 100	250 100	- -	- -	- -	- -
1100	1100	1100	1200	1200	1200	800	-	-
0,09 / 1121	0,09 / 1121	0,09 / 1121	0,1 / 1244	0,1 / 1244	0,1 / 1244	0,09 / 1162	0,054 / 678	0,054 / 678
80	80	80	81	81	81	81,7	81	81
2,74	2,74	2,74	2,68	2,68	2,68	4,57	-	-
28	28	28	12	12	12	25	29	29
6	6	6	7,6	7,6	7,6	4,6	5,5	5,5
273	273	273	266	266	268	255	284	284
106	106	106	95	95	95	87	99	99

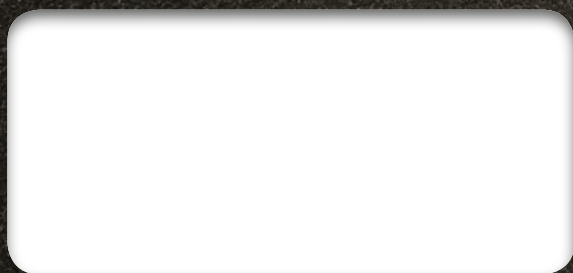

Dealer



 **Heta**

Jupitervej 22 · DK-7620 Lemvig · www.heta.dk